



Product Name	Dimensions	Number	Statement
K186	Widht: 145 mm	1	Connection Hole
	Lenght: 145 mm	2	Camera Field of View
	Heigh: 40mm	3	Lighting Zone
		4	Product Cable



1.FEATURES

- Lighting Color: 4000K,6000K,UV370nm,UV390nm
- Lighting Angle: 15°, 30°, 60°
- Intensity of Illumination: 2.88 k lm
- Number of Leds: 18
- Input Voltage: 24 V
- Input Current (15 μ s): 4 Amp
- Input Current (1 second): 2.8 Amp
- Input Current (1 minute): 1.4 Amp
- Input Current (continuous): 1 Amp
- Dimensions: 14.5 cm x 14.5 cm x 4 cm
- Constant Voltage Usage: Yes
- Diffuser Option: None

3.APPLICATIONS

- Engine Part Inspections
- Packaging Inspections
- Medical Bottle Inspections
- Food Package Inspections
- Surface Inspections
- Microscopic Camera Applications
- Particle Imaging in Liquid
- Particle Size Measurement
- Particle Counting
- Machine Vision
- Cell Identification
- Flame Length Measurement
- Edge Detection
- Material Strain Measurement (elongation / shortening / degradation)
- Motion Detection
- Product Counting
- Color Concentration Information
- Coordinate Information

2.DESCRPTIONS

- Ring lighting is a widely utilized illumination method in image processing projects. This method typically involves a light source consisting of a ring-shaped array of LEDs and offers various advantages.

- Particle Identification
- Cell Imaging
- Machine Monitoring
- Image Processing
- Industrial Led Lighting
- Conveyor Line Lighting
- Robot Vision Applications
- Industry 4.0 Applications
- Machine Lighting
- Bar Light
- Dark Field Light
- Panel Lighting
- Dark Effect Lighting
- Dome Light
- Ring Light
- Panel Light
- Back Light
- Dome Type
- Lighting



Prion Industrial Lighting

Ring Light

K186

4.LIGHT CHARACTERISTICS

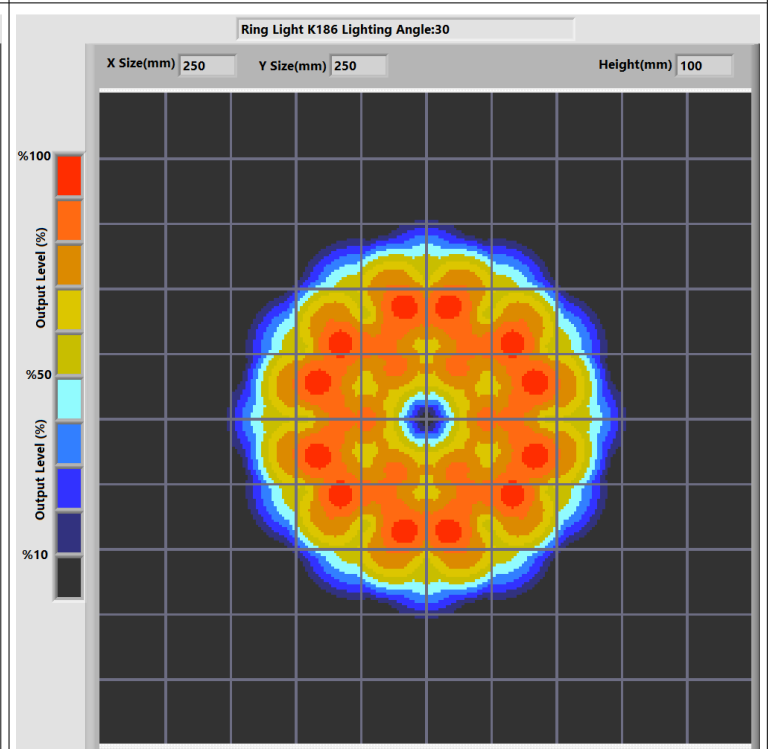
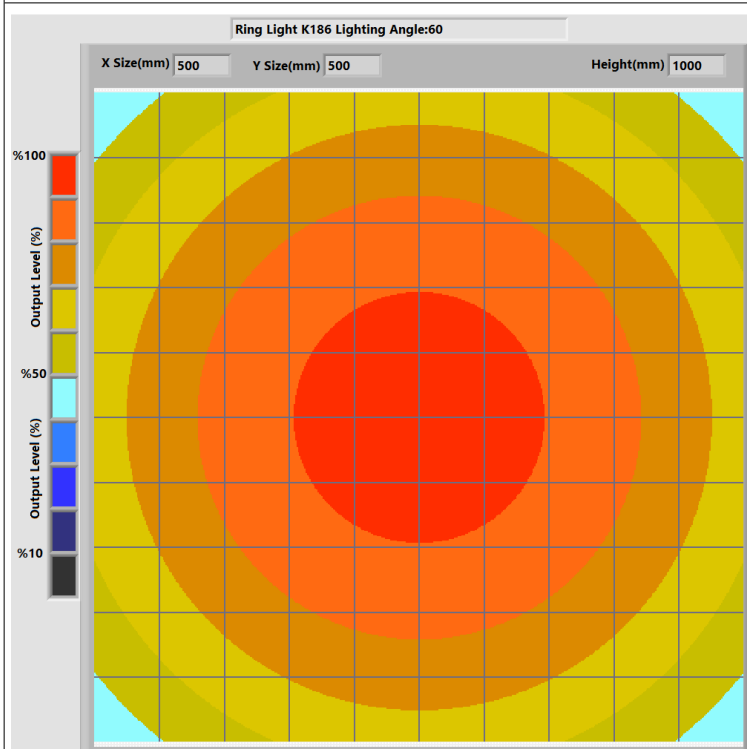
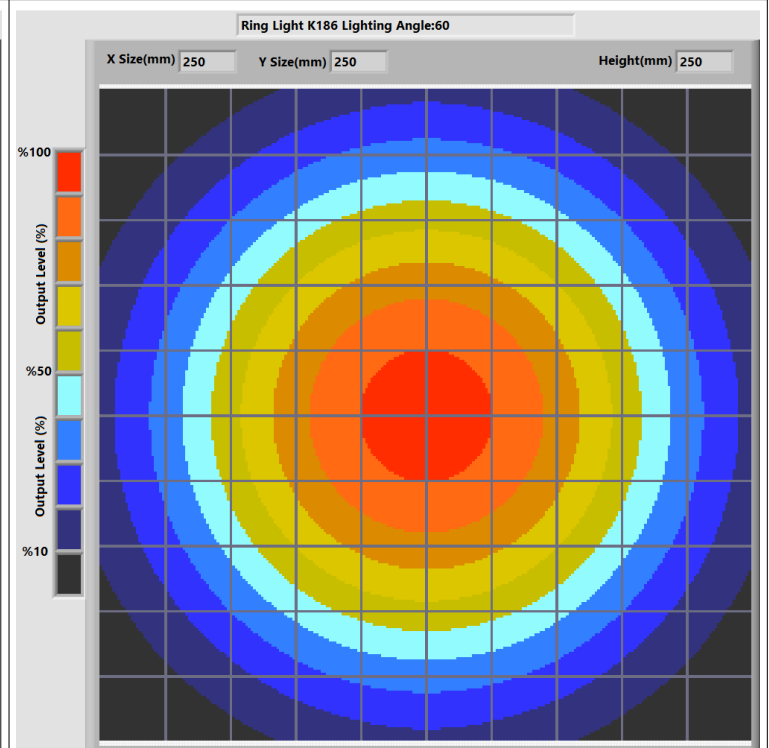
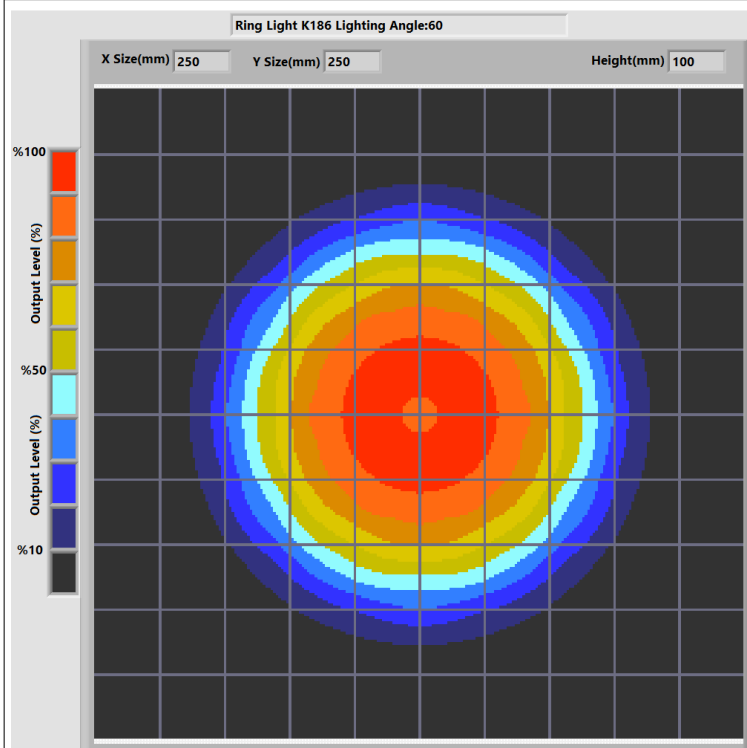

Pelin Street, Nuhoglu Stage 2
Kadiköy/İstanbul/Turkey

E-Mail: info@ludre.com.tr
Contact: +90 216 519 08 54



Prion Industrial Lighting

Ring Light

K186

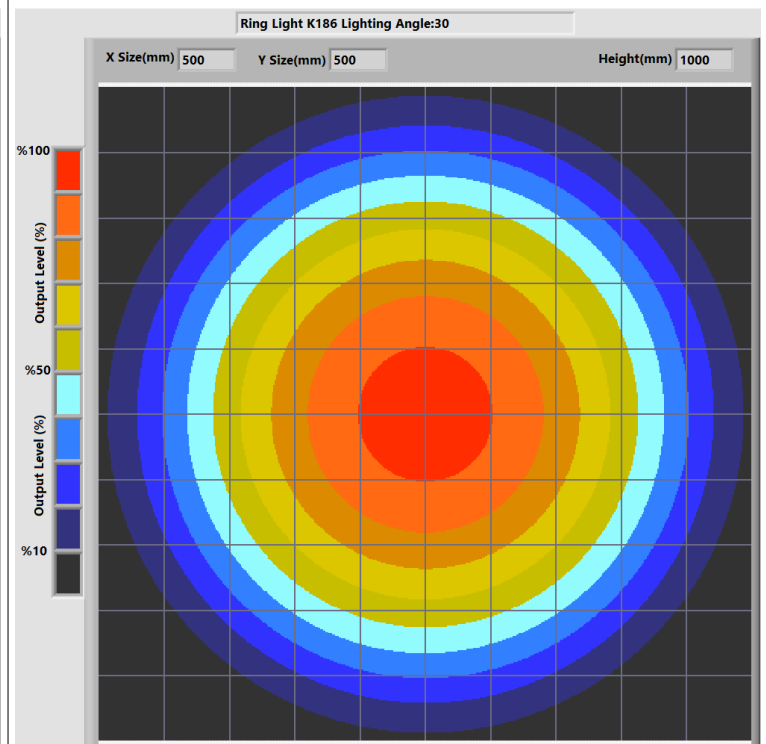
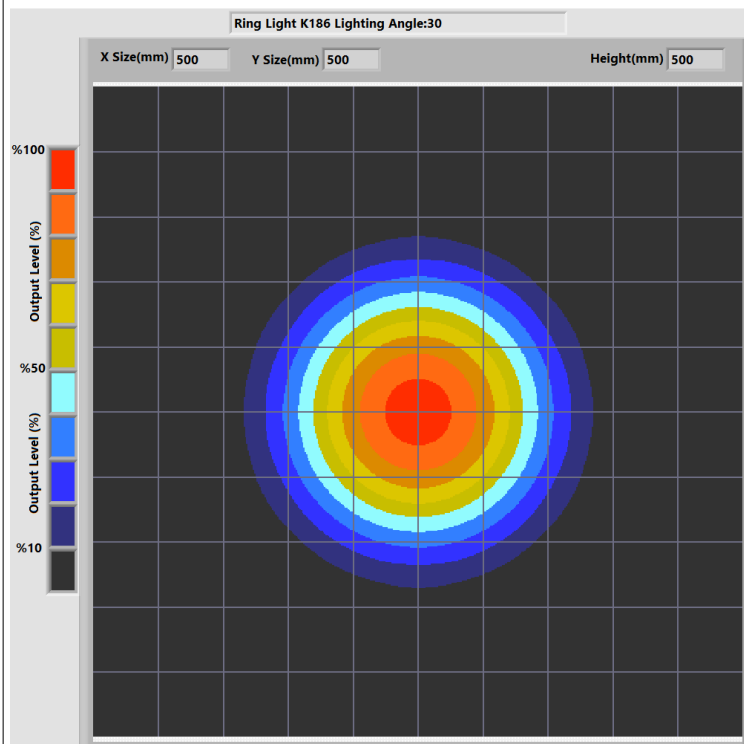
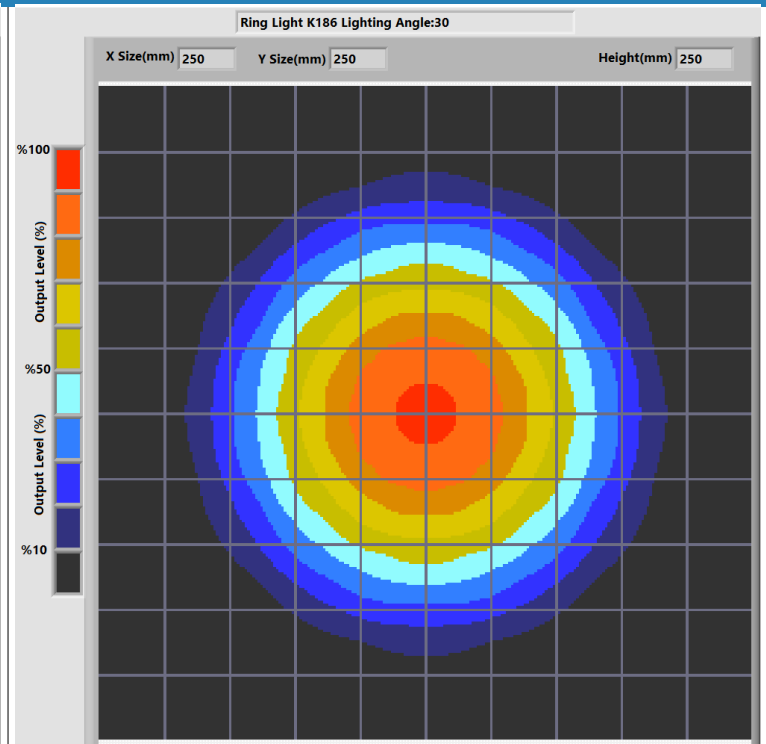
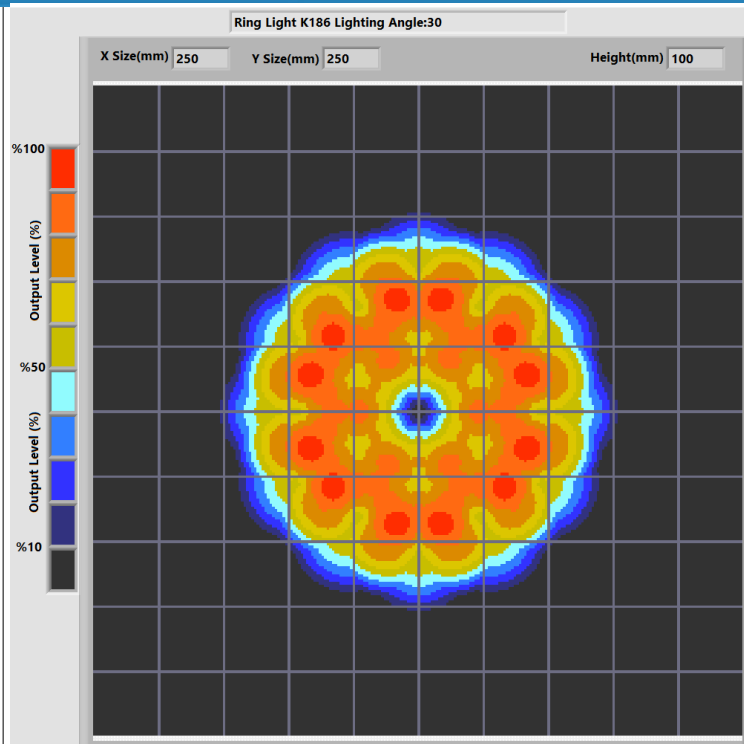

Pelin Street, Nuhoglu Stage 2
Kadikoy/Istanbul/Turkey

E-Mail: info@ludre.com.tr
Contact: +90 216 519 08 54



Prion Industrial Lighting

Ring Light

K186

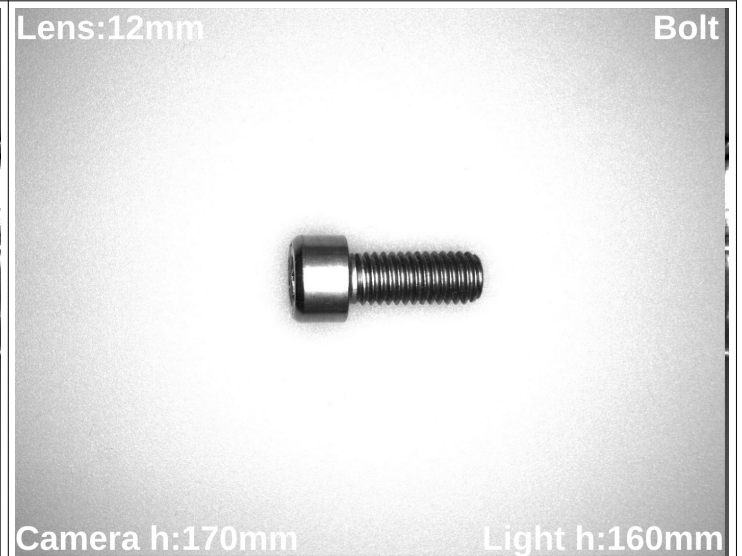
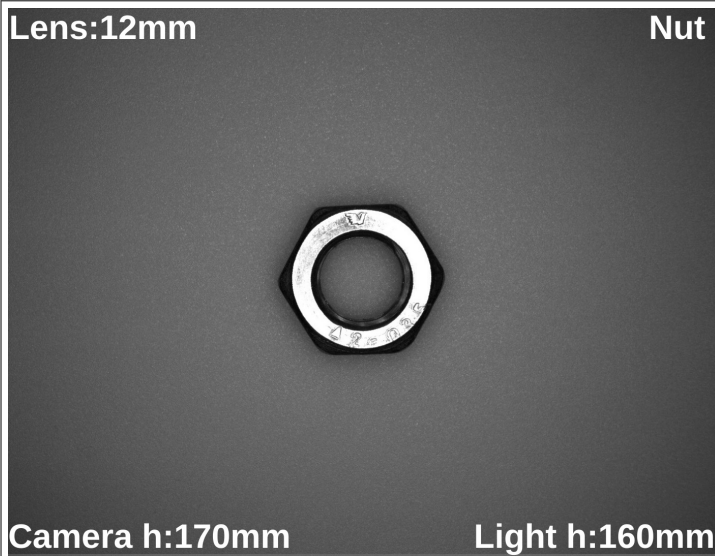
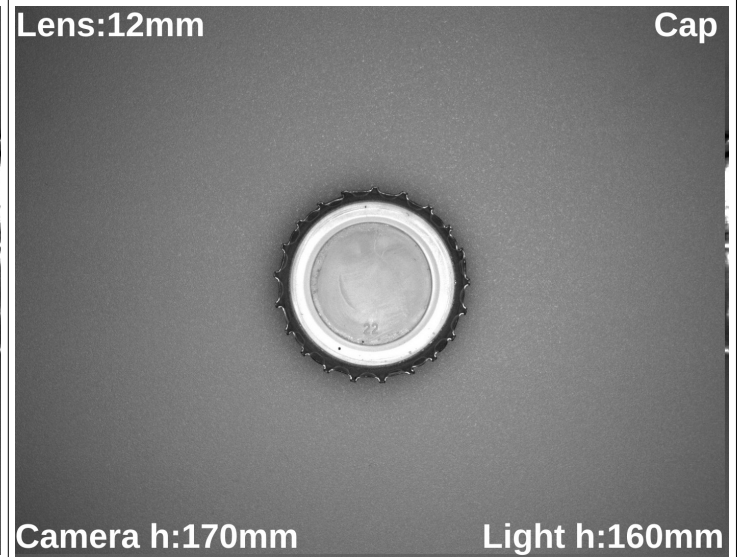
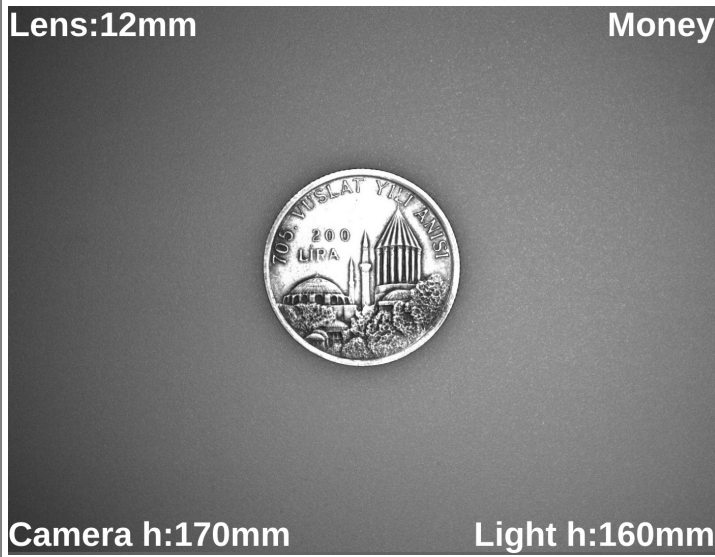



Prion Industrial Lighting

Ring Light

K186

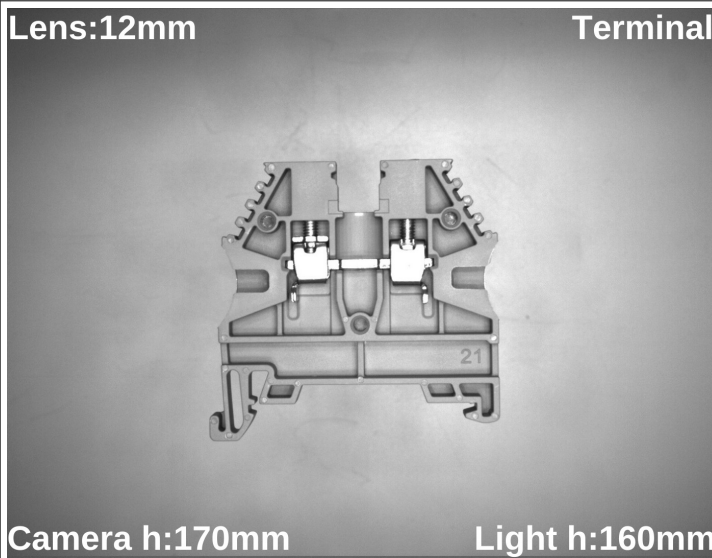
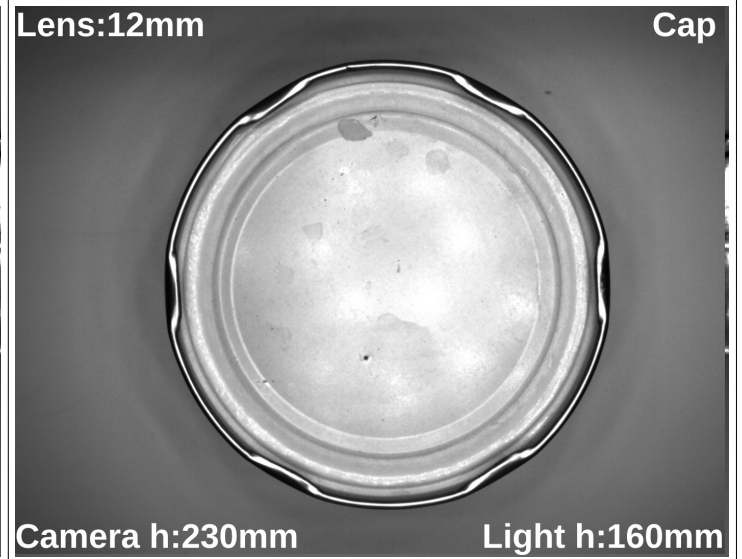
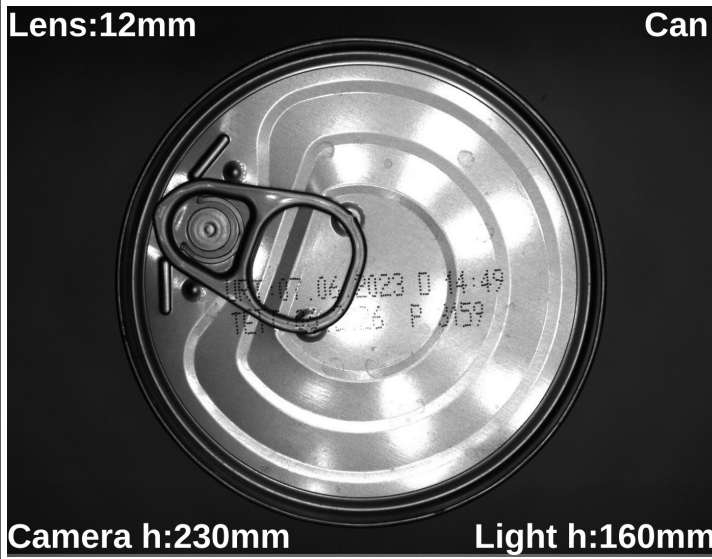

Pelin Street, Nuhoglu Stage 2
Kadiköy/İstanbul/Turkey

E-Mail: info@ludre.com.tr
Contact: +90 216 519 08 54



Prion Industrial Lighting

Ring Light

K186

Lens:12mm

Box



Camera h:230mm

Light h:160mm

Lens:12mm

Pcb

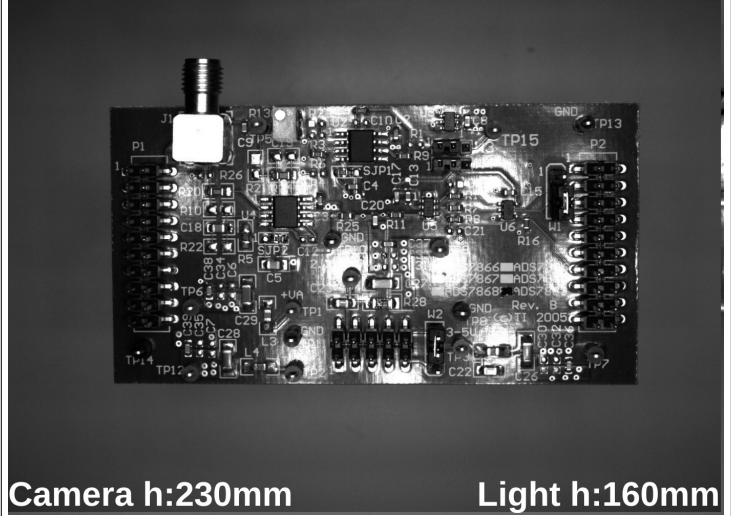

Camera h:230mm

Light h:160mm

Lens:12mm

Package

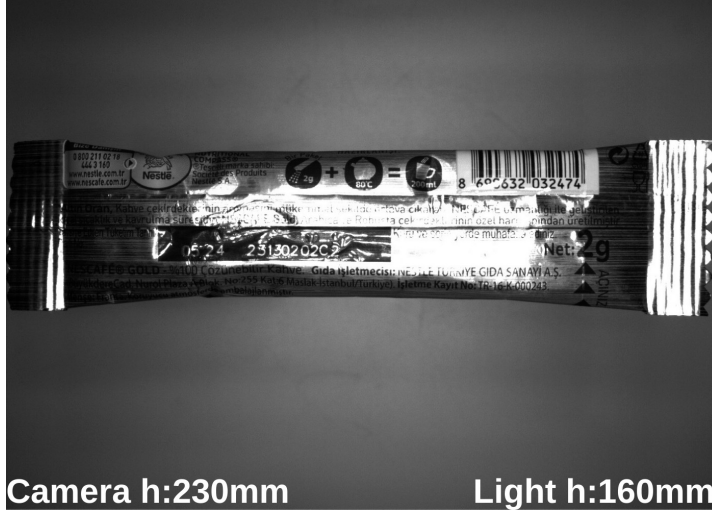

Camera h:230mm

Light h:160mm

Lens:12mm

Package



Camera h:230mm

Light h:160mm



Pelin Street, Nuhoğlu Stage 2
Kadıköy/İstanbul/Turkey

E-Mail: info@ludre.com.tr
Contact: +90 216 519 08 54

5.PRODUCT USE



There are guides in the areas indicated in the figure. You can mount it in these areas with fasteners such as M4 bolts and nuts. There are 12 connection points that you can mount, which are not shown in the image.

These are located on all four sides and on the back of the product. One of the things you should pay attention to during connection is whether the installation is done properly. In installations that are not made properly, vibration may occur during operation and Unwanted situations may occur in your camera images.



The product is powered by a 2M long cable fixed on it.

We need to make the 24V DC+ connection from our cable line with a red stripe, and we need to make the GND connection from our single color cable line.

When the supplies are connected in reverse, the product will not be damaged, but the product will not work. Cuts, breaks, etc. on the cable. If there is a problem, please contact us before using the product.



6.DIMENSIONS

K186

